

Sikla articles
 siFramo 100

TP - F 100

Art. No.:112904

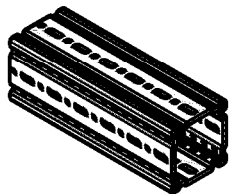

RSK: 382 18 55

AK- F100 - 400

Art. No.:113068

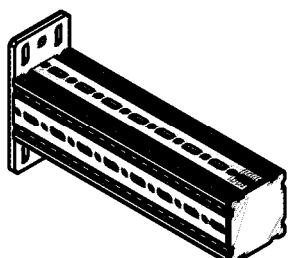

RSK: 382 18 63

AK-F100 - 800

Art. No.:113069

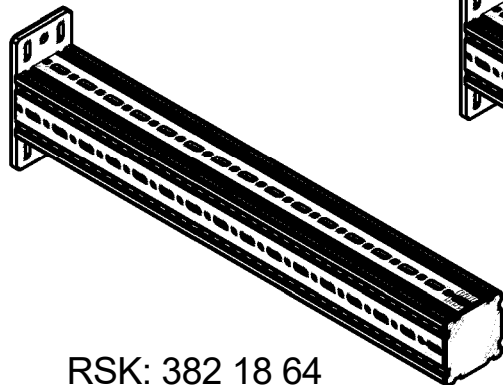

RSK: 382 18 64

AK-F100 - 1200

Art. No.:113419

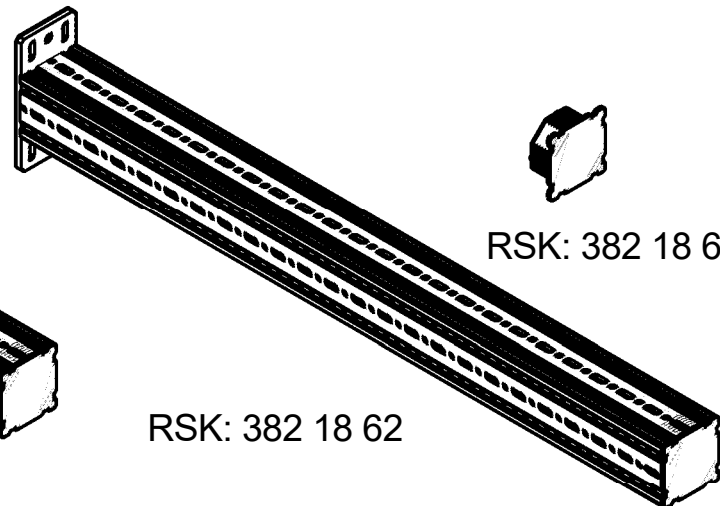

RSK: 382 18 62

ADK F 100

Art. No.:113086



RSK: 382 18 69

TKO-F100 - 400

Art. No.:113071

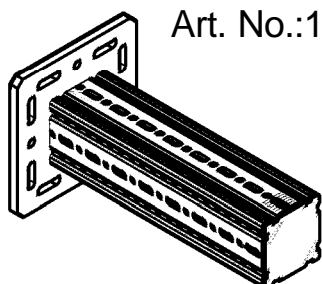

RSK: 382 18 53

TKO-F100 - 800

Art. No.:113072

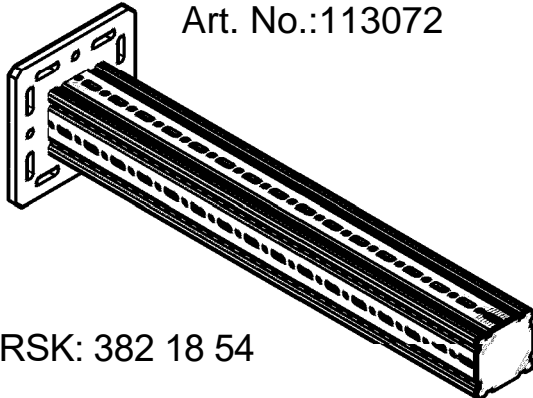

RSK: 382 18 54

TKO-F100 - 1200

Art. No.:113421

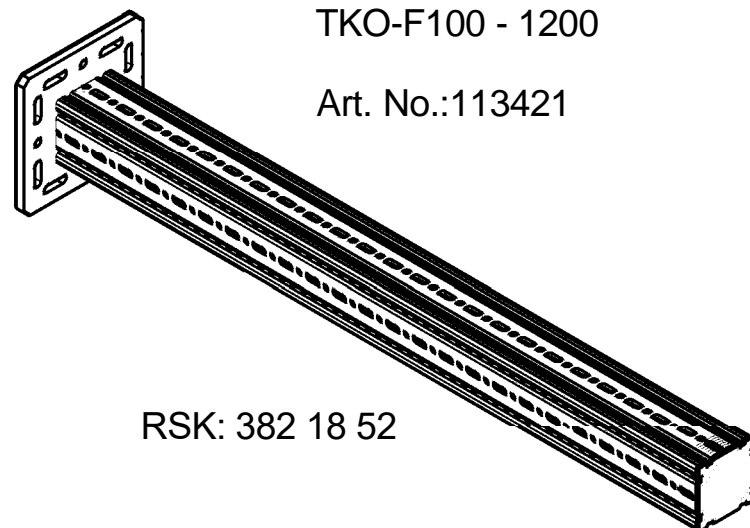

RSK: 382 18 52

WBD-F100-T

Art. No.:113079

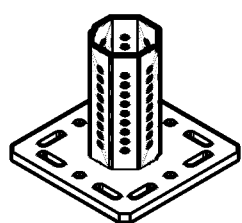

RSK: 382 18 47

WBD-F 100-80/120

Art. No.:113075

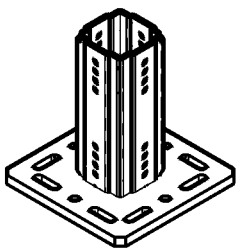

RSK: 382 18 51

WBD-F 100-121/160

Art. No.:117167

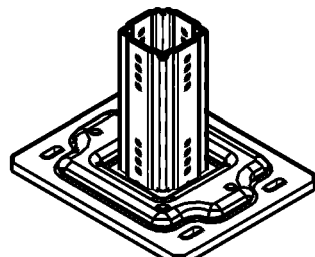

RSK/Art No: 117167

WBD-F 100-161/200

Art. No.:117168

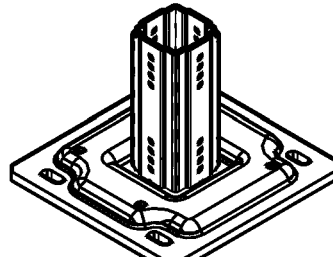

RSK/Art No: 117168

WBD-F 100-201/310

Art. No.:117169

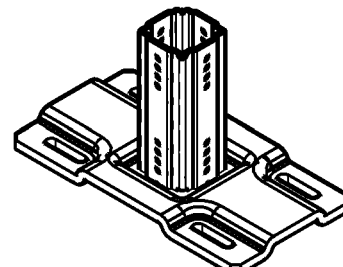

RSK/Art No: 117169

STA F 100

Art. No.:113073

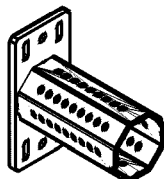

RSK: 382 18 67

STA F 100 - 80

Art. No.:113337

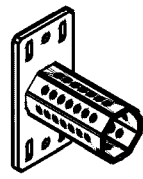

RSK: 382 18 80

SA F 100 - 41

Art. No.:113081

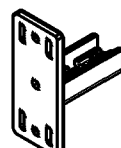

RSK: 382 18 68

TPH F 100 C

Art. No.:113084

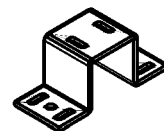

RSK: 382 18 46

TPH F 100 / 80 C

Art. No.:113085

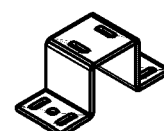

RSK: 388 80 65

FLS-F

Art. No.:192512



RSK: 382 11 46

WD F 100 140/140

Art. No.:113095

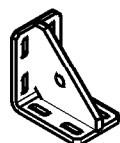

RSK: 388 80 70

Joint GE F 100 100 HCP-

Art. No.:113837

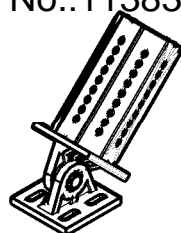

RSK: 388 80 86

Joint GE F 80/120-100 HCP

Art. No.:115863

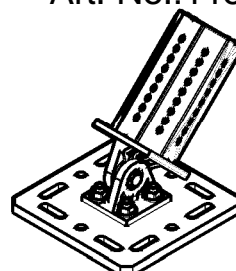

RSK/Art No: 115863

SB-F100 - 40

Art. No.:113083

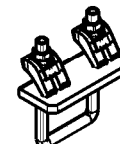

RSK: 382 18 45