

Ventilation

System för ventilation



snabbt
enkelt
säkert!

Förslag på upphängningar av våra produkter

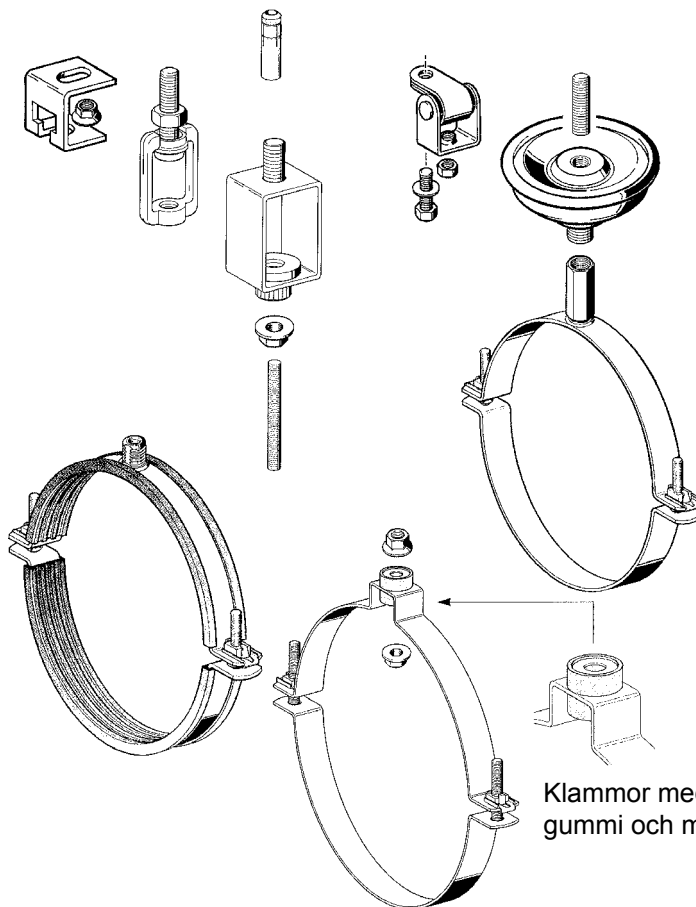

Klammor med eller utan ljuddämpande gummi och med olika anslutningsmöjligheter.

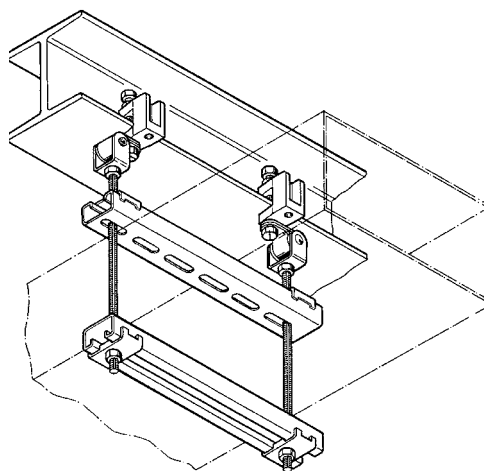
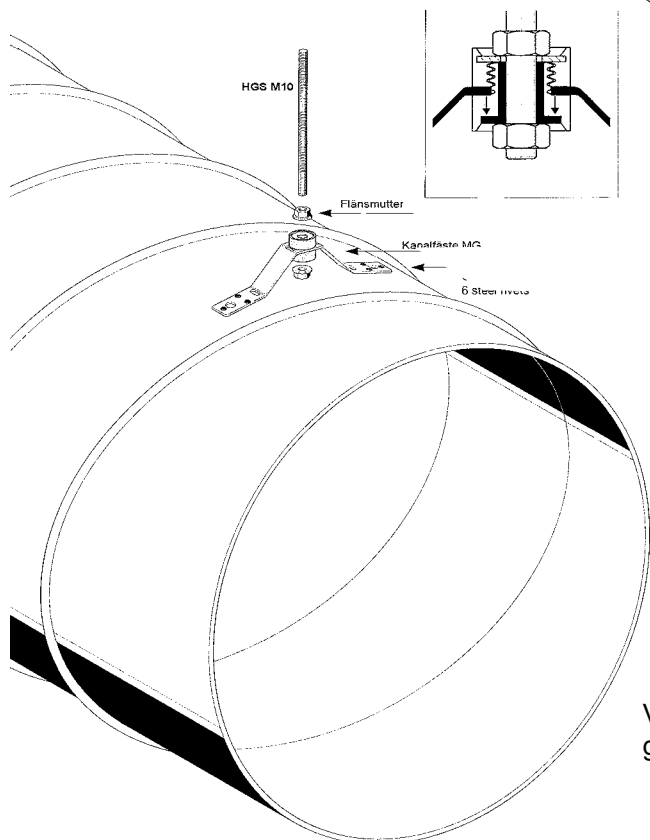

Vi har upphängningsmaterial för både rektangulära och runda ventilationskanaler.

Skenor/Montagetillbehör

Montageskena 27



Montageskena 41



Konsoler 27/41



Pendelkonsoler



pendelfäste/Takjörn



Skenfot WBD



Skarvskena



Vinkelanslutning 27



Skenanslutning 41



Vinkelanslutning 41



Balkbygel 27/41



Klämkonsol



Montagesats



Profilbricka 27/41



Fjädermutter 27/41



Block, Blockset 27/41





Skenor/Montagetillbehör

Art nr	Benämning:	Antal/förp.	Skenor/Montagetillbehör
3821031	Montageskena 27/15 L=2m fzb	10	
3821032	Montageskena 27/27 L=2m fzb	10	
3821033	Montageskena 27/27 L=6m fzb	1	
3821039	Ändstycke 27/15	100	
3821040	Ändstycke 27/27	100	
3820086	Montageskena 41/21/1,5 L=6m fzb	1	
3820786	Montageskena 41/21/1,5 L=2m fzb	1	
26475	Montageskena 41/21/2,5 L=6m fzb	1	
3820787	Montageskena 41/21/2,5 L=2m fzb	1	
3820789	Montageskena 41/41/2,5 L=6m fzb	1	
3820788	Montageskena 41/41/2,5 L=2m fzb	1	
9193785	Montageskena 41/52/2,5 L=6m fzb	1	
9193778	Montageskena 41/52/2,5 L=2m fzb	1	
9193792	Montageskena 41/62/2,5 L=6m fzb	1	
		1	
9174017	Montageskena 41/21/1,5D L=6m fzb	1	
9166757	Montageskena 41/41/2,5D L=6m fzb	1	
9193846	Montageskena 41/52/2,5D L=6m fzb	1	
9193853	Montageskena 41/62/2,5D L=6m fzb	1	
9174152	Montageskena 41-75/65/3,0D L=6m fzb	1	
9174161	Montageskena 41-75/75/3,0D L=6m fzb	1	
3820790	Ändstycke 41/21	100	
3820791	Ändstycke 41/41	100	
9177698	Ändstycke 41/52	100	
9153201	Ändstycke 41/62	100	
9177707	Ändstycke 41-75/65	100	
9177716	Ändstycke 41-75/75	100	
3821034	Konsol 27/27 L=200 fzb	25	
3821035	Konsol 27/27 L=250 fzb	25	
3821036	Konsol 27/27 L=300 fzb	25	
3821037	Konsol 27/27 L=500 fzb	25	
3821038	Konsol 27/27 L=700 fzb	1	
26760	Konsol 41/41 L=200 fzb	10	
26761	Konsol 41/41 L=260 fzb	10	
26762	Konsol 41/41 L=320 fzb	10	
26763	Konsol 41/41 L=445 fzb	10	
26764	Konsol 41/41 L=570fzb	10	
26765	Konsol 41/41 L=820 fzb	1	
3820149	Pendelkonsol US L=150 fzv	1	
3820156	Pendelkonsol US L=200 fzv	1	
3820159	Pendelkonsol US L=250 fzv	1	
3820164	Pendelkonsol US L=300 fzv	1	
3820165	Pendelkonsol US L=400 fzv	1	
3820248	Pendelkonsol MS L=250 fzv	1	
3820255	Pendelkonsol MS L=300 fzv	1	
3820259	Pendelkonsol MS L=350 fzv	1	
3820263	Pendelkonsol MS L=400 fzv	1	
3820271	Pendelkonsol MS L=500 fzv	1	
3820289	Pendelkonsol MS L=600 fzv	1	
3820297	Pendelkonsol MS L=800 fzv	1	
3820300	Pendelkonsol MS L=1000 fzv	1	

Skenor/Montagetillbehör

Art nr	Benämning:	Antal/förp.	Skenor/Montagetillbehör
3820115	Pendelfäste U2/30 L=2m obeh.	1	
3820131	Pendelfäste U2/30 L=2m ffzv	1	
3820172	Pendelfäste U2/30 L=2m fzv	1	
3820175	Pendelfäste U2/30 L=2m A4,2343	1	
3820230	Pendelfäste U3/30 L=2m ffzv	1	
3820180	Pendelfäste U3/30 L=2m fzv	1	
3820214	Pendelfäste U3/30 L=2m obeh.	1	
20011	Pendelfäste U3/30 L=3m ffzv	1	
3820195	Pendelfäste U3/40 L=3m ffzv	1	
26772	Skenfot WBD 41/21	10	
26773	Skenfot WBD 41/41-41/45	10	
26775	Skenfot WBD 41-75/75	5	
26780	Skenfot WBD 41/62 D	5	
26832	Skarvskena SK 41/21	10	
26834	Skarvskena SK 41/41	10	
3821041	Vinkelanslutning CC 27	50	
3821042	Vinkelanslutning CC 27 W	50	
26864	Skenanslutning 41 Typ 1	20	
26865	Skenanslutning 41 Typ 2	10	
26866	Skenanslutning 41 Typ 3	10	
26867	Vinkelanslutning 41 Typ L	25	
26868	Vinkelanslutning 41 Typ 2 L	10	
26869	Vinkelanslutning 41 Typ 3 L	10	
3821044	Balkbygel CC 27	20	
9192566	Balkbygel CC 41 M 8	20	
9183620	Balkbygel CC 41 M10	20	
9191657	Balkbygel CC 41-D M10	20	
26799	Klämkonsol	1 set	
26523	Montagesats KL 1 41/21-41/45	50	
3821053	Profilbricka 27/10 fzb	50	
26527	Profilbricka 41/10 fzb	50	
26528	Profilbricka 41/12 fzb	50	
26529	Profilbricka 41/16 fzb	50	
3821051	Fjädermutter CC 27 M6 fzb	100	
3821052	Fjädermutter CC 27 M8 fzb	100	
3820804	Fjädermutter CC 41 M8 fzb	50	
3820805	Fjädermutter CC 41 M10 fzb	50	
3820806	Fjädermutter CC 41 M12 fzb	50	

Skenor/Montagetillbehör

Art nr	Benämning:	Antal/förp.	Skenor/Montagetillbehör
3821045	Block CC 27 M8	100	
3821046	Blockset CC 27 M8x35 fzb	100	
3821047	Blockset CC 27 M8x75 fzb	100	
3821048	Blockset CC 27 M8x125 fzb	50	
3821049	Blockset CC 27 M8x175 fzb	50	
3821050	Blockset CC 27 M8x275 zb	50	
3820810	Fjäderblock PBH CC 41 M8	50	
3820811	Fjäderblock PBH CC 41 M10	50	
3820812	Fjäderblock PBH CC 41 M12	50	
3820138	Blockset CC 41 M8x35 fzb	100	
3820139	Blockset CC 41 M8x75 fzb	100	
3820140	Blockset CC 41 M8x125 fzb	50	
3820141	Blockset CC 41 M8x175 fzb	50	
3820142	Blockset CC 41 M8x275 zb	50	
3820143	Blockset CC 41 M10x35 fzb	25	
3820144	Blockset CC 41 M10x75 fzb	25	
3820145	Blockset CC 41 M10x125 fzb	25	
3820146	Blockset CC 41 M10x175 fzb	25	
3820147	Blockset CC 41 M10x275 zb	25	

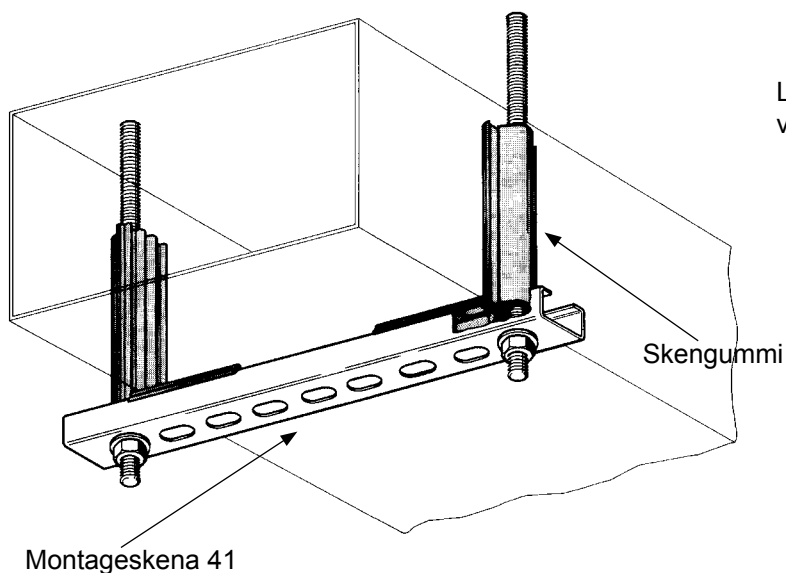

Ljuddämpning av t ex.
ventilationsaggregat.

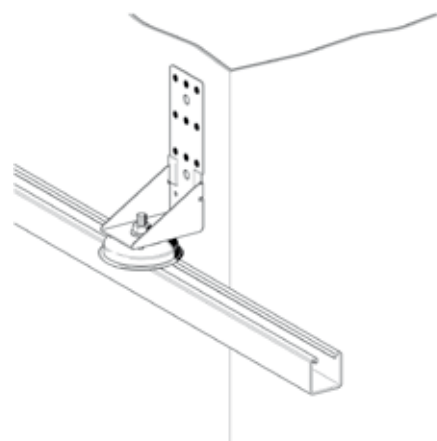

Klammor/Kanalupphängning

Pro Clamp Vent UG



Pro Clamp Vent MG



Ventklamma UG

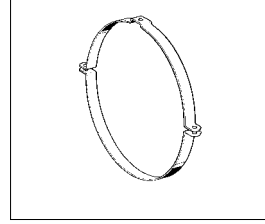

Kanalbygel

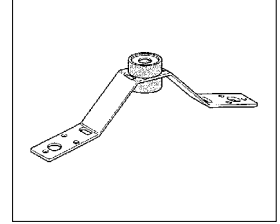

Luftkanalfäste

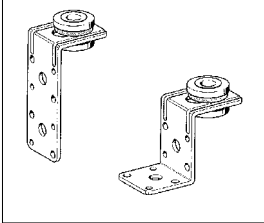

Vinkelanslutn. Stabil

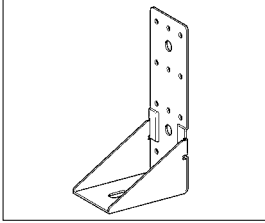

L, Z-järn



Patentband

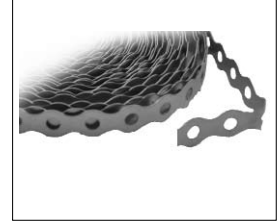

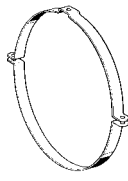
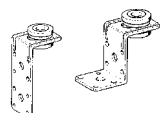
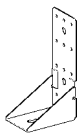

Klammor/Kanalupphängning

Art nr	Benämning:	Antal/förp.	Klammor/Kanalupph.			
28101 3800087 3800088 3800089 3800090 3800091 3800092 3800093 3800094	Pro Clamp Vent M8/M10 80 UG Pro Clamp Vent M8/M10 100 UG Pro Clamp Vent M8/M10 125 UG Pro Clamp Vent M8/M10 160 UG Pro Clamp Vent M8/M10 200 UG Pro Clamp Vent M8/M10 250 UG Pro Clamp Vent M8/M10 315 UG Pro Clamp Vent M8/M10 400 UG Pro Clamp Vent M8/M10 500 UG	50 50 25 25 25 10 10 10 10				
9180452 9180470 9180488 9180515 9180533 9180551 9180578 9180596 9180614	Pro Clamp Vent M8/M10 80 MG Pro Clamp Vent M8/M10 100 MG Pro Clamp Vent M8/M10 125 MG Pro Clamp Vent M8/M10 160 MG Pro Clamp Vent M8/M10 200 MG Pro Clamp Vent M8/M10 250 MG Pro Clamp Vent M8/M10 315 MG Pro Clamp Vent M8/M10 400 MG Pro Clamp Vent M8/M10 500 MG	50 50 25 25 25 10 10 10 10				
28120 28121 28122 28123 28124 28125 28126 28127 28128	Ventilationsklamma 560 UG Ventilationsklamma 600 UG Ventilationsklamma 630 UG Ventilationsklamma 710 UG Ventilationsklamma 800 UG Ventilationsklamma 900 UG Ventilationsklamma 1000 UG Ventilationsklamma 1120 UG Ventilationsklamma 1250 UG	1 1 1 1 1 1 1 1 1			 Finns även med ljuddämpat gummi	
27436	Kanalbygel	100				
27438 27440	Luftkanalfäste L MG Luftkanalfäste Z MG	100 100				
9158534	Vinkelanslutn. Stabil 170/90	10				
3824868 3824869 23605	L-järn 25x3 fzb L-järn 25x4 fzb L-järn 40x6 fzv	100 100 1				
3820065 3820066 23606	Z-järn 25x3 fzb Z-järn 25x4 fzb Z-järn 40x6 fzv	100 100 1				
23542 23547 3816915 3816816 3817021 23553 3816847 23569	Patentband 12x 0,8 ffzv Patentband 13x1,2 plast Patentband 17x0,8 ffzv Patentband 18x1,4 plast Patentband 17x1,0 Aluminium Patentband 12x1,0 2343 Patentband 17x0,8 2343 Montageband 25x0,9 ffzv	10m 10m 10m 10m 10m 10m 10m 25m				

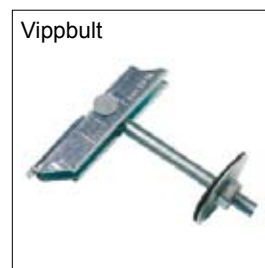
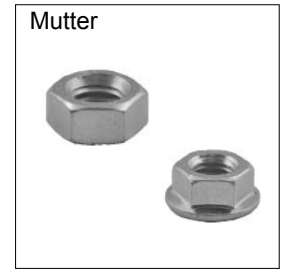
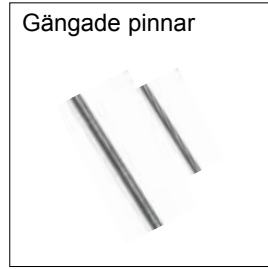
Gångstänger/Fästmaterial



HGS/Fästmaterial

Art nr	Benämning:	Antal/förp.	HGS/fästmaterial
3820933	HGS M 8x2000 4.6 fzb	25	
3820941	HGS M 10x2000 4.6 fzb	25	
3820958	HGS M 12x2000 4.6 fzb	1	
3820900	HGS M 10x1000 5.8 fzv	1	
3829020	HGS M 12x1000 5.8 fzv	1	
3820901	HGS M 10x2000 5.8 fzv	1	
3820903	HGS M 12x2000 5.8 fzv	1	
27642	Gängad pinne M 8x 25 fzb	100	
26598	Gängad pinne M 8x 40 fzb	100	
27645	Gängad pinne M 8x 70 fzb	100	
27646	Gängad pinne M 8x100 fzb	100	
27648	Gängad pinne M 8x150 fzb	100	
27644	Gängad pinne M 8x175 fzb	100	
27647	Gängad pinne M 8x200 fzb	100	
27649	Gängad pinne M10x 25 fzb	100	
27650	Gängad pinne M10x 40 fzb	100	
27654	Gängad pinne M10x 70 fzb	100	
27658	Gängad pinne M10x100 fzb	100	
27660	Gängad pinne M10x125 fzb	50	
27662	Gängad pinne M10x150 fzb	50	
27666	Gängad pinne M10x175 fzb	50	
27667	Gängad pinne M10x200 fzb	50	
25212	Skruv M6S M 8x 20 fzb	100	
3825701	Skruv M6S M 8 x25 fzb	100	
3825702	Skruv M6S M 8x 30 fzb	100	
25218	Skruv M6S M 8x 40 fzb	100	
3825703	Skruv M6S M 8x 50 fzb	100	
25222	Skruv M6S M 10x 25 fzb	100	
25219	Skruv M6S M 10x 30 fzb	100	
25220	Skruv M6S M 10x 40 fzb	100	
25238	Skruv M6S M 10x 45fzb	100	
3825704	Skruv M6S M 10x 50 fzb	100	
25235	Skruv M6S M 10x 60 fzb	100	
25239	Skruv M6S M 12x 30 fzb	50	
25240	Skruv M6S M 12x 40 fzb	50	
25234	Skruv M6S M 12x 45 fzb	50	
25241	Skruv M6S M 12x 50 fzb	50	
25243	Skruv M6S M 12x 65 fzb	50	
25232	Skruv M6S M 12x 70 fzb	50	
25233	Skruv M6S M 12x 80 fzb	50	
25311	Skruv M6S M 8 x25 fzv	100	
25312	Skruv M6S M 8x 30 fzv	100	
25313	Skruv M6S M 8x 40 fzv	100	
25314	Skruv M6S M 8x 50 fzv	100	
25322	Skruv M6S M 10x 40 fzv	50	
25323	Skruv M6S M 10x 50 fzv	50	
25324	Skruv M6S M 10x 65 fzv	50	
25328	Skruv M6S M 12x 40 fzv	50	
25330	Skruv M6S M 12x 50 fzv	50	
25332	Skruv M6S M 12x 65 fzv	50	

HGS/Fästmaterial

Art nr	Benämning:	Antal/förp.	HGS/fästmaterial
3819978	Mutter M6M M 8 fzb	100	
3819979	Mutter M6M M 10 fzb	100	
10239	Mutter M6M M 12 fzb	100	
25423	Mutter M6M M 8 fzv	100	
25424	Mutter M6M M 10 fzv	100	
25426	Mutter M6M M 12 fzv	100	
3820011	Flänsmutter M 8 fzb	100	
3820012	Flänsmutter M 10 fzb	100	
3820013	Flänsmutter M 12 fzb	100	
3820862	Betongskruv MMS-S 7,5x 35 fzb	100	
3820863	Betongskruv MMS-S 7,5x 40 fzb	100	
3820864	Betongskruv MMS-S 7,5x 45 fzb	100	
3820865	Betongskruv MMS-S 7,5x 50 fzb	100	
3820866	Betongskruv MMS-S 7,5x 60 fzb	100	
3820867	Betongskruv MMS-S 7,5x 80 fzb	50	
3820868	Betongskruv MMS-S 7,5x100 fzb	50	
3820874	Betongskruv MMS-I 7,5x60 fzb	100	
3820114	Betongskruv MMS-Pan SH 7,5x 45 fzb	100	
3820860	Betongskruv MMS-Pan SH 7,5x 45 fzb	100	
3820861	Betongskruv MMS-Pan SH 7,5x 45 fzb	50	
3820935	Walldog 3,7x 32 försänkt krom	100	
3820937	Walldog 3,7x 32 försänkt vit	100	
3820936	Walldog 3,7x 32 pan krom	100	
3820938	Walldog 3,7x 32 pan vit	100	
3821134	Walldog 3,7x 50 försänkt krom	100	
3821135	Walldog 3,7x 70 försänkt krom	100	
3821136	Walldog 3,7x 50 pan krom	100	
3821137	Walldog 3,7x 70 pan krom	100	
3829307	Byggskriv m. fläns 6,5x40 fzb	100	
3829308	Byggskriv m. fläns 6,5x50 fzb	100	
3829309	Byggskriv m. fläns 6,5x60 fzb	100	
3829310	Byggskriv m. fläns 6,5x75 fzb	100	
3829311	Byggskriv m. fläns 6,5x100 fzb	100	
25794	Byggskriv m. fläns 6,3x 32 fzb m. borrs.	100	
25795	Byggskriv m. fläns 6,3x 38 fzb m. borrs.	100	
25796	Byggskriv m. fläns 6,3x 50 fzb m. borrs.	100	
25797	Byggskriv m. fläns 6,3x 65 fzb m. borrs.	100	
25798	Byggskriv m. fläns 6,3x 80 fzb m. borrs.	100	
25799	Byggskriv m. fläns 6,3x100 fzb m. borrs.	100	
25840	Montageskriv 4,2x14 fzb	1000	
25841	Montageskriv 4,2x19 fzb	500	
25842	Montageskriv 4,2x25 fzb	500	
25843	Montageskriv 4,2x32 fzb	500	
25844	Montageskriv 4,2x45 fzb	250	
25845	Montageskriv 4,2x65 fzb	200	
3827388	Montageskriv 4,2x13 fzb m. borrs.	250	
3827389	Montageskriv 4,2x25 fzb m. borrs.	250	
3827390	Montageskriv 4,2x32 fzb m. borrs.	250	

HGS/Fästmaterial

Art nr	Benämning:	Antal/förp.	HGS/fästmaterial
28027	Plåtskruv R6B red. 4,2x9,5 fzb	500	
28028	Plåtskruv R6B red. 4,2x13 fzb	500	
28029	Plåtskruv R6B red. 4,2x19 fzb	500	
28020	Plåtskruv RXB 3,5x13 fzb	500	
28024	Plåtskruv RXB 4,2x19 fzb	500	
28025	Plåtskruv RXB 4,2x25 fzb	500	
3828207	Mea Plugg MZK M 6	100	
3828205	Mea Plugg MZK M 8	100	
3828206	Mea Plugg MZK M 10	50	
12055	Mea Plugg MZK M 12	25	
3828003	Mea Lättbetongplugg GB 10x55	25	
3828004	Mea Lättbetongplugg GB 12x60	20	
3828005	Mea Lättbetongplugg GB 14x75	10	
3829293	Lättbetongplugg TML 6	100	
3829294	Lättbetongplugg TML 8	50	
3829295	Lättbetongplugg TML 10	50	
3829277	Sharkie Nylonplugg 5x25	200	
3829278	Sharkie Nylonplugg 6x30	200	
3829279	Sharkie Nylonplugg 8x40	200	
26806	Korrugerat plåttakfäste M 8	100	
26808	Korrugerat plåttakfäste M10	100	
26807	Korrugerat plåttakfäste M 8 lek. mutter	100	
26809	Korrugerat plåttakfäste M 10 lek.mutter	100	
26811	Korrugerat plåttakfäste ljuddämp.	100	
27494	Korrugerat plåttakfäste 10,5 mm	100	
3820579	Vippbult M8x100 Vds	100	
3820580	Vippbult M8x200 Vds	50	
3820583	Vippbult M10x100 FM	50	
3820584	Vippbult M10x200 FM	50	
26800	Justerbygel P M 8	25	
26801	Justerbygel P M10	25	

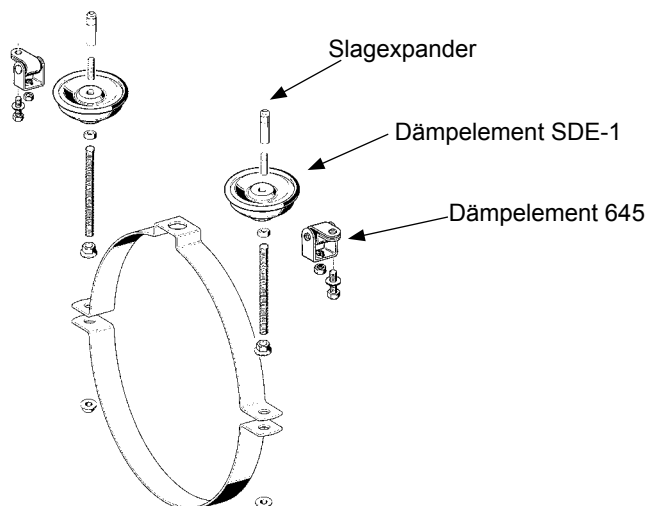

Ljuddämpning

Dämpelement SDE



Dämpelement 645



Gummifot

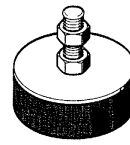

kanalbygel

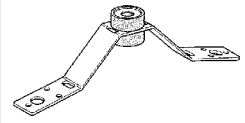

Luftkanalfäste

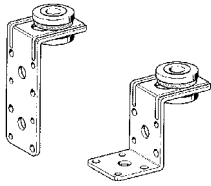

Dämpelement AKE



Ljuddämp. HGS M 8

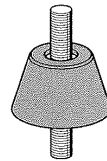

Dämpelement SDE-2

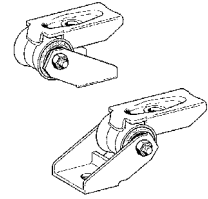

Dämpelement SDE-M16

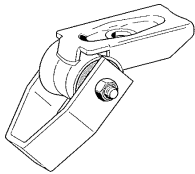

Dämpelement SDE-2FP

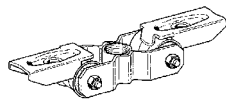

Dämpgummi



Cellgummi



Glasfiberband

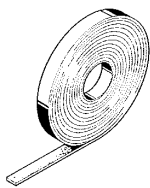



Ljuddämpning

Art nr	Benämning:	Antal/förp.	Ljuddämpat
26680 26684	Dämpelement SDE-1 M10 fzb Dämpelement SDE-1 3G fzb	25 25	
26692 26694	Dämelement ledfäste 645 M 8 fzb Dämelement ledfäste 645 M 10 fzb	100 100	
26675	Ljuddämpande gummifot M 12 fzb	1	
27436	Kanalbygel	100	
27438 27440	Luftkanalfäste L MG Luftkanalfäste Z MG	100 100	
9193983	Dämpelement AKE 41	20	
9192584	Ljuddämpat för HGS M8 GMT	1	
9161406 9161062	Dämpelement SDE 2- SBV Dämpelement SDE 2- SBZ	10 10	
9161053	Dämpelement SDE 2- M16 UG	10	

Ventilation

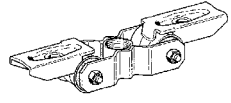
Ljuddämpning

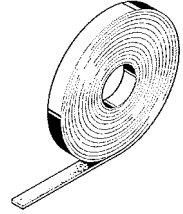
Art nr	Benämning:	Antal/förp.	Ljuddämpat
9161071	Dämpement SDE 2-FP 1	10	
27002 27004 9146520 9146539 9146548	Dämpgummi 25x2,5 Dämpgummi 30x3,0 Dämpgummi 40x4,0 Dämpgummi 50x5,0 Dämpgummi 70x6,0	30m 30m 30m 30m 30m	
26750 26752 26754 26756	Cellgummi 20x3,0 Cellgummi 10x4,0 Cellgummi 25x3,0 Cellgummi 30x3,0	10 10 10 10	
9193037 9193044 9193051 9193068 9193075 9193082	Glassfiberband 25x2 Glassfiberband 25x2 Glassfiberband 25x2 Glassfiberband 25x2 Glassfiberband 25x2 Glassfiberband 25x2	10 10 10 10 10 10	

Ljud- och vibrations-
dämpande lösningar

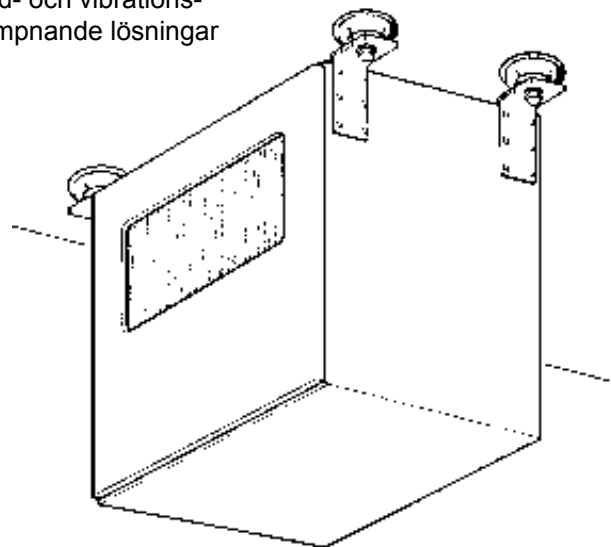

System för ventilation

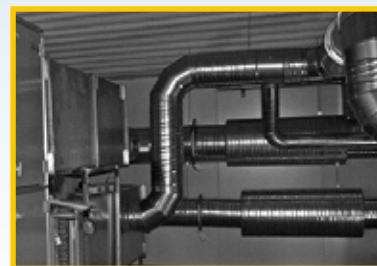
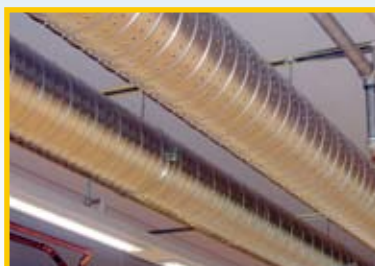

www.rethermkruge.se

Retherm Kruge AB
August Barks gata 1
421 32 Västra Fröljunda
Tel: +46 (0)10 2200200
www.rethermkruge.se
info@rethermkruge.se